

MODULAR TINY M-TBAR



COMPACT SIZE, POWERFUL ILLUMINATION
with built-in driver technology



4 HIGH POWERED LEDS



EASY MOUNTING



CURRENT CONTROL

- **ANGLE CHANGER** compatible
- **IP RATING** **IP67**
- **CURRENT CONTROL**
integrated onto cable
- **EASY-CHAIN TOGETHER
MULTIPLE LIGHTS**
with no change to LED spacing
- **EASY MOUNTING**
- **AUTO-STROBE OVERDRIVE**



TPL VISION IS AN **ISO 9001**
CERTIFIED MANUFACTURER.

CONTACT YOUR LOCAL SALES
REPRESENTATIVE FOR **MORE DETAILS.**

MODULAR TINY M-TBAR

FEATURES OVERVIEW

**ROBUST, ANODIZED
ALUMINIUM HOUSING**

IP67 RATING
with **vent** to avoid
condensation.

±5° LENS ANGLE

Add **Angle Changers**
for diffusion and to change
beam angle.

MAGNETIC ATTACHMENT
for testing **Angle Changers** & **SCREWS**
for fixing them in final application.

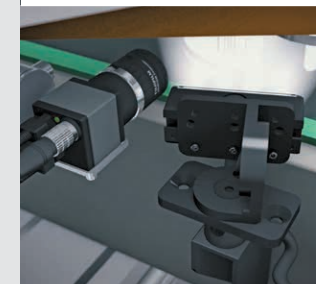
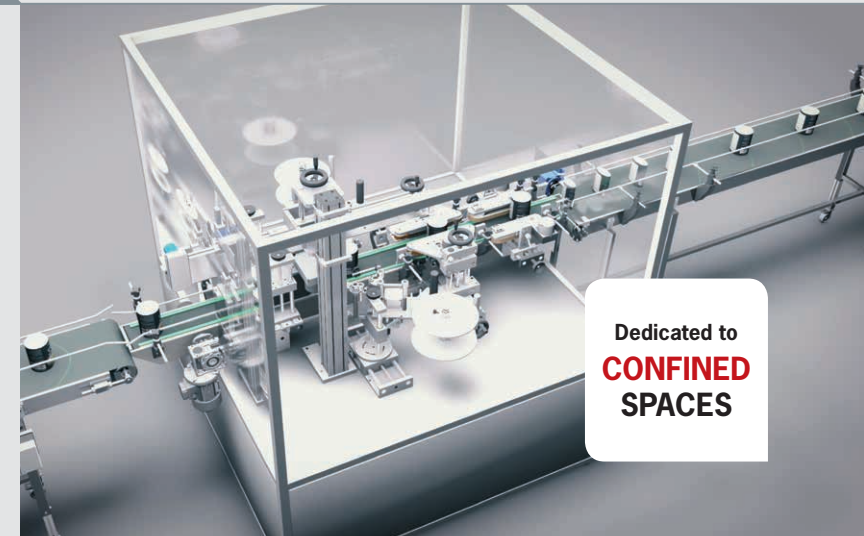

MODULAR TINY M-TBAR



FEATURES OVERVIEW

NO CHANGE IN LED SPACING

when you chain the bars together.

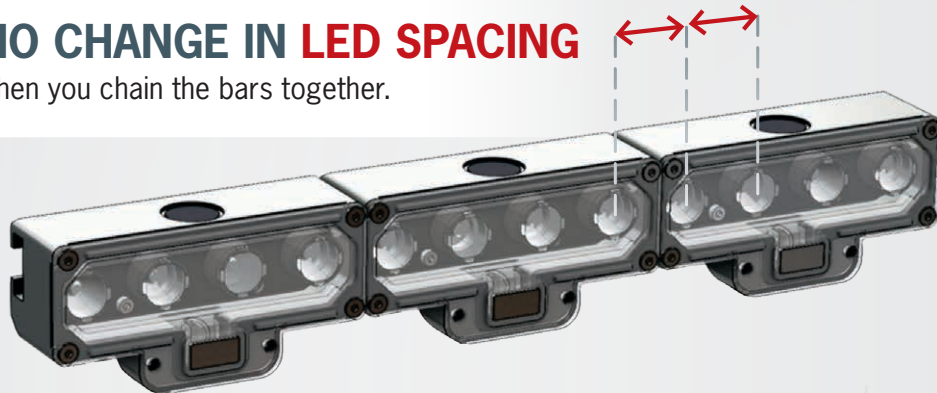

CABLE MOUNTING FLEXIBILITY



EASY T-SLOT MOUNTING (nuts provided).



POWER SUPPLY:

- **AUTOSTROBE** – automatic OverDrive brightness when product is strobed <math><10\text{ms}</math>
- **DIMMING** on continuous mode and overdrive mode
- **<math><15\mu\text{s}</math> RISE TIME**
- **IP67 ENCLOSURE**

■ STANDARD M12 5 PINS

- 24VDC
- GND
- PNP
- NPN
- DIMMING 0-10V = 100-30%



9 DIFFERENT ANGLE CHANGERS:



CHANGE THE BEAM ANGLE EASILY

- ➔ **Narrow $\pm 10^\circ$** (Standard & Polarised)
- ➔ **Medium $\pm 17^\circ$** (Standard & Polarised)
- ➔ **Wide $\pm 25^\circ$** (Standard & Polarised)
- ➔ **Line $\pm 9-16^\circ$** (Standard & Polarised)
- ➔ **Polariser alone**

MODULAR TINY M-TBAR

ANGLE CHANGER LIGHTING DATA

AC-TBAR-N
(Narrow angle)



AC-TBAR-M
(Medium angle)



AC-TBAR-W
(Wide angle)



AC-TBAR-L
(Line light)



ANGLE CHANGER

DISTANCE
100 mm

DISTANCE
200 mm

NO ANGLE CHANGER

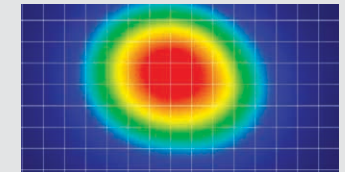
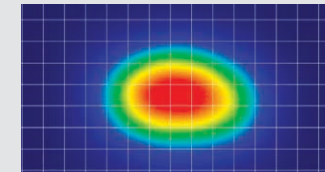

AC-TBAR-N
(Narrow angle)

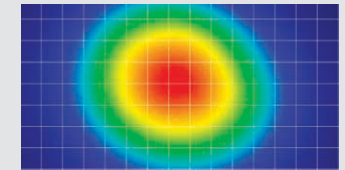
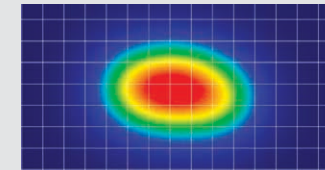

AC-TBAR-M
(Medium angle)

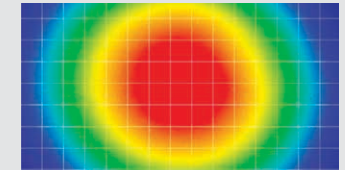
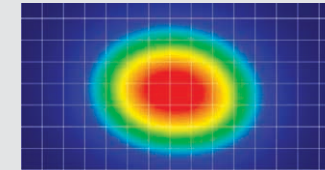

AC-TBAR-W
(Wide angle)

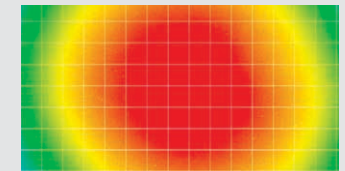
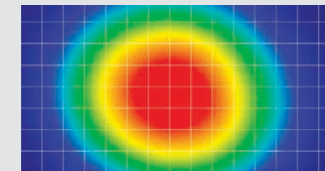

AC-TBAR-L
(Line light)

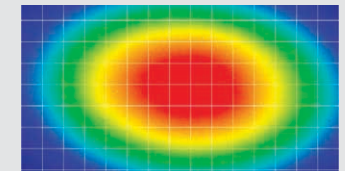
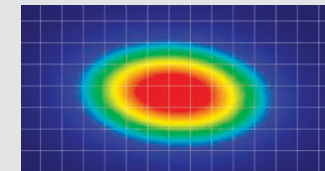

1 Square = 10mm x 10mm

MODULAR TINY M-TBAR

TECHNICAL DATA

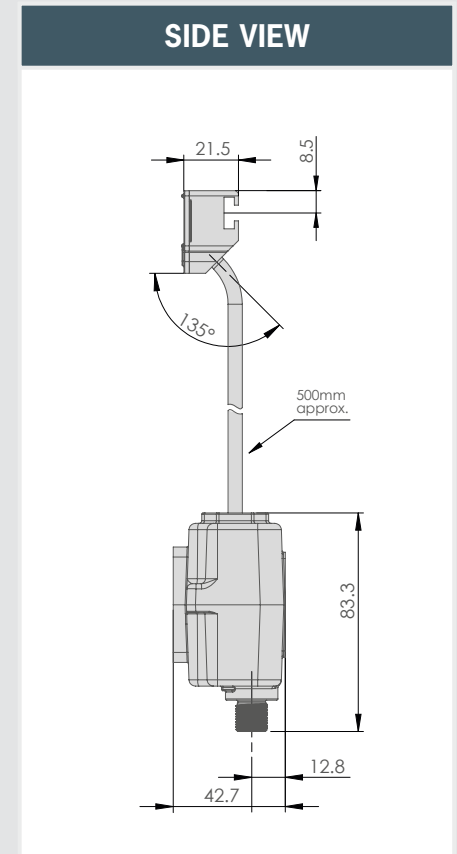
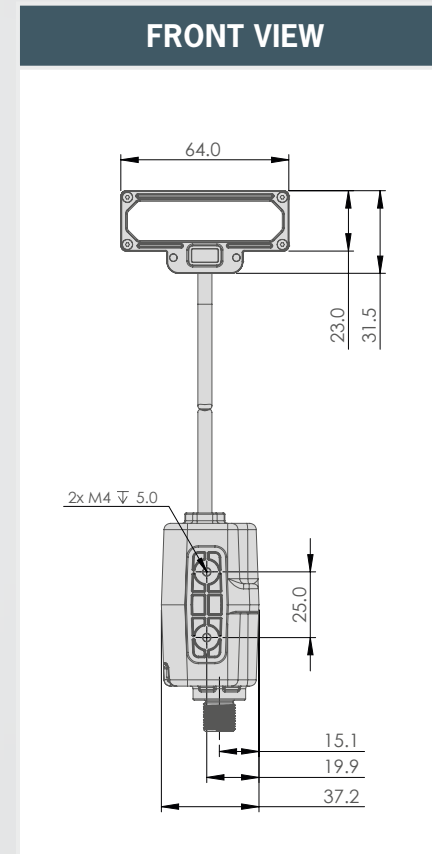
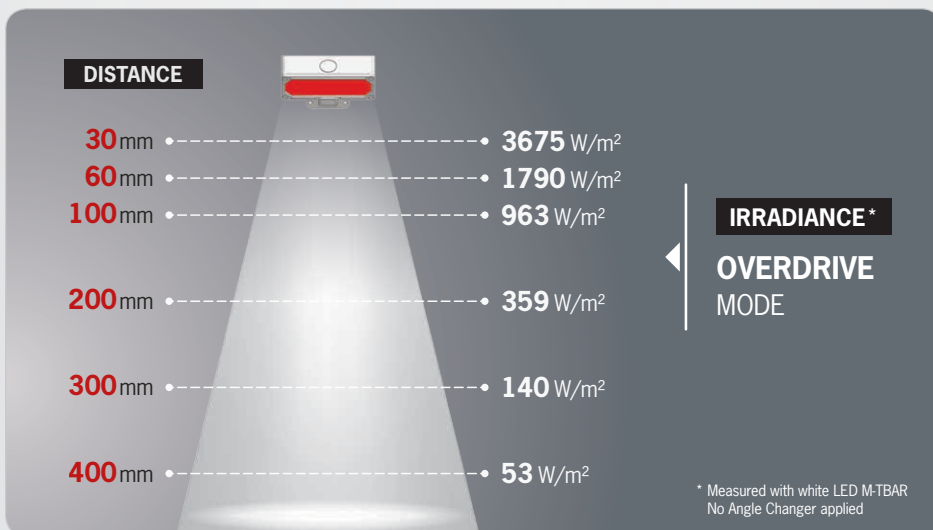
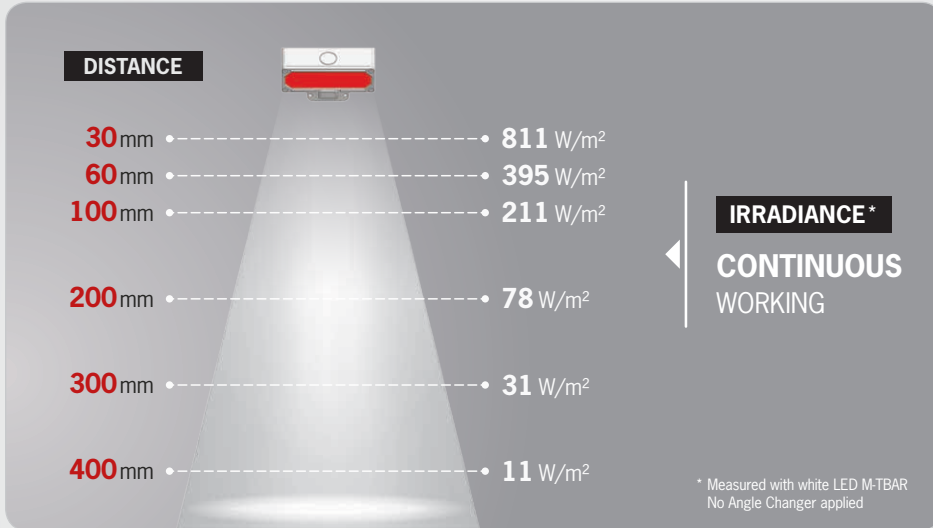

	Length (mm)	Width (mm)	Thickness (mm)
Light	64	31.5	21.5
Cable	length: 500mm		

	Length (mm)	Width (mm)	Thickness (mm)
Power supply	83.3	37.2	42.7
Connector	M12 5 pins		

MODULAR TINY M-TBAR



TECHNICAL DATA & ORDER REFERENCES

M-TBAR	
Electronics	
Power Supply	24 VDC ±10%
Functioning Mode	Continuous working (CW), Strobe OverDrive
Rise and Fall Time	15µs/15µs, respectively
Wiring	M12 5 Pin Connector
Strobe Conditions	10ms Maximum On-time at 10% Duty Cycle
Peak Consumption (WHI) (OverDrive peak)	36 W
Optics	
Colours	White, Red, Green, Blue & Infrared
Mechanical	
Dimensions	64 x 31.5 x 21.5 mm
Weight	0.15 kg (light + control box)
Materials	Aluminium (anodised), ABS, PC, Stainless Steel, Neodymium
Mounting/Fixing	M4 T-NUT or M2 screws
Environment	
Operating Temperature	-10° to +40°C / 80% of humidity without condensation No thermal shock (max temperature variation: 10°C in 24h)
Storage Temperature	-20° to +60°C / 80% of humidity without condensation No thermal shock (max temperature variation: 10°C in 24h)
IP Protection	IP 67
Labels	RoHS-CE-UKCA-WEEE



Get more information:

www.tpl-vision.com

M-TBAR:

M-TBAR	LED NUMBER	COLOUR
	4	WHI (white)
		630 (red)
		525 (green)
		470 (blue)
		850 (infrared)

EXAMPLES:

- Modular Tiny M-TBAR 4 LEDs white → M-TBAR-4-WHI
- Modular Tiny M-TBAR 4 LEDs red → M-TBAR-4-630

ANGLE CHANGERS:

AC-TBAR	ANGLE	OPTION: POLARIZER
	N (narrow)	P1
	M (medium)	
	W (wide)	
	L (line light)	
	POLARIZER ONLY	
	POL1	

EXAMPLES:

- Narrow → AC-TBAR-N
- Narrow with polariser → AC-TBAR-N-P1
- Polarizer only → AC-TBAR-POL1

ANGLE CHANGER COMBO:

Ref: **AC-TBAR-CO-SM**

CONTENT:

- x1 AC-TBAR-N
- x1 AC-TBAR-M
- x1 AC-TBAR-W
- x1 AC-TBAR-L
- x1 AC-TBAR-POL1



SWIVEL MOUNT:

Ref: **SWIVEL-MOUNT-T**

